

Repair Conditions

1. Parts that can be repaired:
 - Internal electronic circuitry
 - Damage caused by incorrect connection, inter-terminal shorting, or driving is not covered by warranty.
2. Note that this device will not be covered under warranty if the housing has been opened.
3. **ACUVANCE** assumes no responsibility for damage to the receiver or servo caused by the incorrect connection of this product.
4. Note that if the repair card (located below) or the repair sheet (on the homepage) is not properly filled out, repair and return of the ESC may be delayed.

Warranty			
Item Manufacture no.	RAD	Purchase date	(M/D/Y) / /
		Warranty term	3 months from purchase date
Customer Address E-mail Phone number	(@)	Phone no.	
Name			

Note that if the date and location of ESC purchase are not entered on the warranty card, you will be charged for repairs even within the warranty term.

- If a failure occurs within three months of purchasing the ESC, write the symptoms of the problem and operating conditions in the section below and attach this to the product. For repair, send the ESC to the distributor where you purchased the product or directly to ACUVANCE (Technical Service Department).
- ACUVANCE assumes no responsibility for damage or losses that occur during transportation. Please take note of this beforehand.
- When listing the symptoms for a repair request, you can conveniently use the repair request sheet on the ACUVANCE homepage and then send this along with the warranty card.
(Click the "repair" section located in the upper-right side of our website. Then click "repair request sheet", located on the left side.)

Repair card

1. Symptoms

Write the symptoms of the problem, giving as much detail as possible.

2. Payment for repair charges

I would like to be contacted if there is compensation

※ Though it depends on the details of the repair, indicating in advance that no contact is necessary will normally shorten the time it takes to complete the repair.

ACUVANCE CORPORATION Technical Service Dept.

7F, Shin-Osaka Marubiru Annex 1-18-22
Higashinakajima Higashiyodogawa-ku
Osaka 533-0033 Japan.
FAX +81-6-6379-1190
www.acuvance.co.jp/english

Shop name (address, and phone. no.)

330375

ACUVANCE

HIGH PERFORMANCE E.S.C.

RAD

RAD Owner's Manual



PRECAUTION FOR USE

⚠ WARNING

Before using this product, carefully read the important warnings described in this instruction manual to understand the instructions thoroughly.

⚠ DANGER

Instructions that the user must observe to prevent serious injury.

⚠ WARNING

Instructions that the user must observe to prevent accidents.

CAUTION

Useful information for handling this product.

About batteries

⚠ DANGER To prevent fumes, fire, or burns

Improper use of the battery is very dangerous. The battery must be handled carefully. Incorrect wiring or short-circuiting of wiring may cause fire or fumes. Before connecting or disconnecting the battery to or from the speed controller (ESC), be sure to turn off the power switch of the ESC. When the battery is not in use, disconnect it from the ESC or charger, and store it in a suitable location free of any loose wires or screws.

About cable Connections

⚠ DANGER To prevent fumes, fire, or burns

Incorrect wiring may cause fire or fumes that can damage both the ESC and battery beyond repair.

About the aluminum body

⚠ DANGER To prevent burns

The surface of the body can be extremely hot after heavy load driving. Please handle the unit carefully after operation to avoid risk of burn.

Handling precautions

⚠ WARNING To avoid accidents or product failure

Do not modify the ESC in any way. Use it only for its intended purpose. Keep the ESC away from flames or heat. Avoid splashing any liquid, such as water, on the ESC.

FEATURES

Thank you for choosing RAD. Please read this instruction manual carefully before using this product, and use it correctly and safely. Please keep it carefully after reading.

FEATURES

- By adopting a new power MOS-FET, more powerful output characteristics are realized while having the [Silky-Feeling] unique to ACUVANCE.
- Equipped with battery reverse connection protection circuit (Refer Page.22).
- Radio Control industry's first [PYRAMID Shaped] top face design that enhances cooling efficiency when FAN is installed.
- A hologram-like cutting method is used for the cutting surface of the aluminum housing. Produced a more gorgeous sense of luxury.
- Equipped with XARVIS XX setting function [torque level / torque endpoint]
- Supports two-way communication using "TAO III", "Ne-St", and "FUTABA S.BUS system compatible transmitter"

Please check our website and official Twitter for details on the features and the latest information. (@ACUVANCE_JAPAN)

Specifications

Power Supply	6.0V~8.5V
Continuous/spontaneous max current	Max. current of battery
Compatible motors	Sensored motor - unrestricted (when boost turbo is disabled)
Dimensions	W30.5xD35.0xH20.5mm
Weight	48.7g
Regulator for receiver/servo	6V/3A

INDEX

- P.4 ————— How to connect the ESC
- P.6~P.9 ————— Preparations Before Driving Tuning
- P.10~P.21 ————— the Driving Experience

⚠ DANGER To prevent fumes, fire, or burns

Insufficient soldering of the male connector of the cable connected to the motor, or poor contact due to deterioration of the connector surface may cause damage to the ESC or motor. Please replace the male connector on a regular basis, by doing so, it keeps to enable to energize state of the contact points between the connectors in good condition at all times.

Please connect as shown below

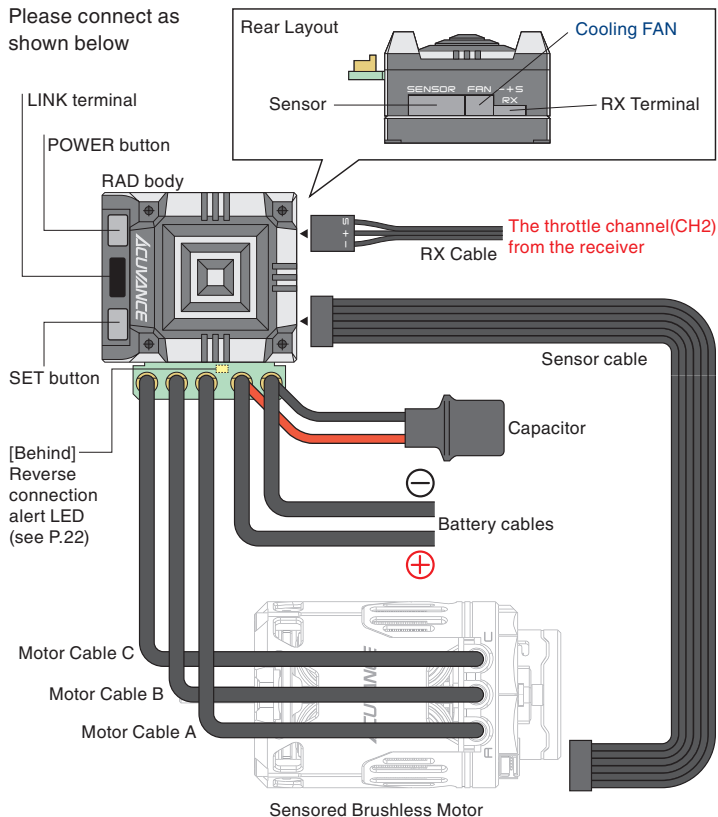

• POWER BUTTON

It is the button to turn the unit ON or OFF.

• LINK TERMINAL

Terminal for communication with TAO III, Ne-St. S.BUS Adapter (OP-15127), etc. are also connect here.

• SET BUTTON

It is used for setting change in the RAD main unit. It is also used to switch between "ESC mode" setting of the main unit, and "Link mode" setting with TAO III.

• COOLING FAN CONNECTION TERMINAL

ACUVANCE optional cooling fan or fan connection terminal with our motor. Since it is designed exclusively for ACUVANCE cooling fan, other manufacturers' cooling fans cannot be used. (If you use a fan of a different brand, the fan and ESC may be damaged.)

⚠ WARNING If the sensor cable is not connected, has not been properly inserted, has been disconnected, or is loosely connected, all the LEDs will blink (highspeed blinking). While in this state, all operations will not be received. If this occurs, check the connection for the sensor cable or replace the cable.

⚠ WARNING When inserting the connector, pay attention to the way in which it being inserted. If inserted backwards, the device will not operate.

⚠ WARNING Be sure to match the cables to the symbols A, B, and C on the ESC. Failure to follow this precaution can result in loss of control over the motor speed, or subject the ESC and motor to large currents. Unlike brushless motors without a sensor, swapping these cables does not change the rotating direction of the motor. If necessary, change the direction of rotation at the ESC*.

* To switch the direction of rotation, it is essential to have the rotation direction change function in the ESC. This machine has this function (P.16)

⚠ WARNING When replacing the motor cable, use a soldering iron with a broad tip and high output rating (as high as 60 W) and work swiftly. A soldering on with the low output rating will not melt enough of the solder resulting in a poor soldering connection which can cause cables to loosen under vibration or loose connections. Also, subjecting the internal parts to excessive heat over prolonged periods (10 seconds or more) can damage them. (Be careful not to shortcircuit the terminals with solder)

⚠ WARNING Be sure to use screws with a length of 8 mm or less to secure the motor to the motor mount. If the screw is too long, it may interfere with parts inside the motor, resulting in malfunctions such as short circuit.

PREPARATIONS BEFORE DRIVING

When using for the first time, the neutral position of ESC with the transmitter you have will not match. If you try driving before the initial setting is completed, the motor may start rotating at the same time as the switch is turned on. Since it is very dangerous, be sure to perform the following "initial setting of the radio throttle position" when turning on the power for the first time. (The motor will not rotate during initial setting.)

Initial setting of radio throttle position

Immediately after purchasing or immediately after replacing the transmitter, it is necessary to store the neutral point, forward MAX point and reverse (brake) MAX point of the transmitter in the ESC. Follow the procedure below.

Preparations Before setting, please set all settings (EPA = endpoint adjustment, maximum braking amount, etc) for the throttle of the transmitter to a neutral position (zero value). If the settings are different, the ESC may not detect the throttle input and calibration will not be performed successfully.

Preparations When performing the initial setting, be sure that the sensor cable is connected to the motor and ESC. If the sensor cable is not connected, has not been properly inserted, has been disconnected, or is loosely connected, all the LEDs will blink (high-speed blinking). Check the connection for the sensor cable or replace the cable as all operations will not be received while it is in this state. Also, in addition to when performing the initial settings, the sensor cable should always be connected when the vehicle is being driven.

The three motor cables (A, B, C) may be left disconnected but be careful to not have the cable connectors touch each other as they will short.

Preparations If performing the initial settings with the motor cables connected, secure the motor in a motor mount or other device, and remove the pinion gear to keep the car from moving unexpectedly.

How to Calibrate

Supports SANWA super response <SSR> mode

SSR mode is an original system from Sanwa Denshi Co. Ltd.

1 <<Before making calibration>>

Be sure the ESC power is turned off, and make sure the ESC is properly connected to the battery, motor (only the Sensor cable needs to be connected), and receiver. Then turn the transmitter power on.

2 <<Calibration mode>>

If you press and hold the POWER button for 2 to 3 seconds while the power is OFF, the LED green blinks 3 times at the same time, the LED green starts blinking and the initial setting mode is entered. Then release the POWER button.



Press and hold the POWER button for 2 to 3 seconds



LED Green - Orange Blink for 3 seconds at the same time



LED blinking

3 <<Setting of the neutral point>>

While the LED blinks green, set the transmitter throttle to the neutral position and press the POWER button briefly. After that, the blue LED will blink.

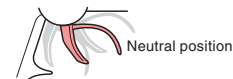

▼ Press POWER button



Green blinking LED changes to Blue blinking LED



4 <<Setting of the high point>>

While the blue LED is blinking, set the throttle on the transmitter to the maximum forward position and press the set button on the ESC once. The red LED will start blinking.

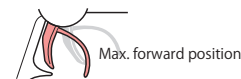

▼ Press POWER button



Blue blinking LED changes to Red blinking LED



5 <<Before making calibration>>

While the red LED is blinking, set the throttle on the transmitter to the maximum reverse position of Step 4, and press the set button on the ESC once. All LEDs will blink three times.



▼ Press POWER button



Red blinking LED changes to All LEDs Blink three Times



This completes the initial settings for the transmitter positions. The ESC automatically changes to the standby mode (p. 8).

Important

If you performed the procedure described by the ※ under Step 4 above, <<Setting of the high point>>, switch the throttle channel on the transmitter between normal and reverse after completing the initial setting for all transmitter positions.

Caution

The throttle position for the transmitter may become misaligned due to changes or deterioration over time. If the LED lights are flashing while the ESC is in standby mode, readjust the initial settings for the transmitter.

Powering OFF

Press and hold the POWER button for 2 seconds to turn off the power.

PREPARATIONS BEFORE DRIVING

Verifying the transmitter positions have been correctly set to their initial settings

The standby LED (see below) should be the only one **illuminated** when the throttle is in the neutral, maximum forward, and maximum reverse (brake) positions. If the Standby LED is **unlit** in all other positions, the initial setup has been completed properly. (The standby LED is the only LED that alternately illuminates and goes out when adjusting the throttle)

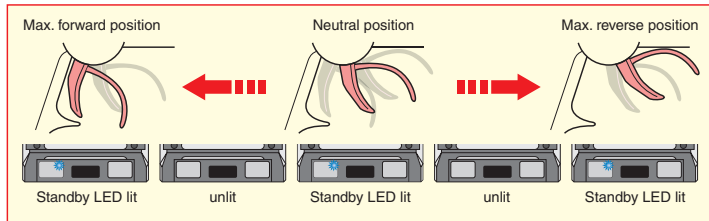

If the standby LED does not follow this lighting pattern, the initial setting was not completed properly. Make sure the throttle related adjustment on the transmitter are initialized and the RX cable is properly connected to the receiver. Then, retry the initial setting procedure.

※ Depending on the configuration of the vehicle, **the car may move in reverse** when the throttle is operated in the forward direction. If your car displays this behavior, **change the rotation direction of the motor** (P.16).

Checking standby mode

At the time of shipment, the standby mode is as shown in the figure on the right. Each LED has the following meaning.

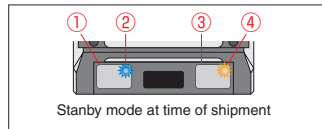

① LED<green> : **Factory shipped condition = unlit**

※ If the **battery voltage becomes lower than the cutoff voltage** (P.16) while driving, the green LED will blink and the car will drive at extremely low speeds. If this occurs, **replace the battery**.

② LED<blue> : **Factory shipped condition = lit**

Standby LED when setting mode (P.10) is in ESC mode. Unlit during Link mode.

※ Under "ESC Mode", <blue> LED will be blinking if the program selected (P.12) is "Boost/Turbo Disabled", or both "Full Boost Timing"(P.17) and "Full Turbo Timing" (P.19) are disabled.

③ LED<red> : **Factory shipped condition = unlit**

Standby LED when setting mode is in Link mode. Unlit during ESC mode.

※ Under "Link Mode", <red> LED will be blinking if the program selected (P.12) is "Boost/Turbo Disabled", or both "Full Boost Timing"(P.17) and "Full Turbo Timing" (P.19) are disabled.

④ LED<orange> : **Factory shipped condition = lit**

Illuminated when the reverse drive feature (P.16) is set to ON. Unlit when set to OFF.

※ If the ESC heats up to temperature limits while driving, the motor will remain at low speed and the Orange LED will blink. If this situation occurs, discontinue operation until the ESC temperature drops back to ambient temperature. If the Orange LED starts blinking after driving for only a brief period of time, check to see if the gear ratio settings are overloading the motor.

[Important] Safety feature for driving in reverse

On radio controlled cars, the same throttle controls are used for braking and driving in reverse. This can cause car to move backward when the intention is to apply the brakes. Suddenly trying to reverse the motor while it is rotating forward can place severe stress to the gears, motor, and ESC, sometimes resulting in internal damage. The RAD is equipped with the following feature to prevent this. **After applying the brakes, before reversing, the ESC will wait 1 second or more for the throttle to return to neutral and for the motor to go from rotating in a forward direction to coming to a complete stop (it will not go into reverse within the span of 1 second).**

This feature prevents unintentional reversing even if the reverse drive feature is set ON on the ESC. It prevents damage to the drivetrain of the car and potential collision with other vehicles, as well as many other possible problems, and is essential to allow short braking action when turning corners.

※ Note, this safety feature cannot be disabled. However, as detailed in [Reverse drive ON/OFF and motor rotating selection](P.16), when configuring to crawler-oriented settings, vehicle movement that occurs once the throttle is placed in the brake position will be specialized for reverse driving (the brake will not work), thus disabling this function.

This completes the preparation before driving. Connect the motor and enjoy driving.

※ When using lithium polymer batteries, set the cutoff voltage before driving to 3.2V/cell (1 recommended)(P.16)

Selecting setting modes

First, select either [ESC mode] or [Link mode]. Select ESC mode to adjust various features on the ESC, or Link mode to change function settings for the effector. At time of shipment, ESC is set to ESC mode.

Selecting Setting Modes

- In standby mode, press and hold the set button for 4 seconds or longer.
 Press the set button For 4 seconds or longer
- The LEDs (blue & red) alternately blink indicating the setting mode is now active.



Repeating the same procedure alternates between [ESC mode](blue) and [Link mode](red).

Important The numerical setting ranges and unit of adjustment differ depending on the mode selected (P.12 to 20). Refer to the following section for setting procedure in ESC mode, or the instruction manual supplied with the programming card for setting procedures in Link mode.

Flow for changing setting and ESC mode

※ If the initial settings have not been completed, the following procedure cannot be performed.

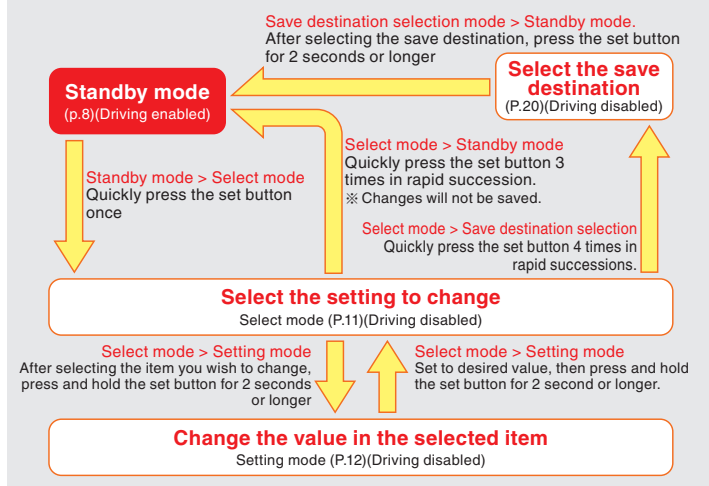

Select mode (when Setting mode = ESC mode)

In Standby mode (P.8), quickly press the set button once. The green LED will start blinking indicating the ESC is in Select mode. (While in Select mode, the motor will not rotate even if the transmitter throttle is operated.)

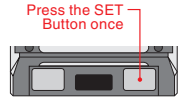

Select mode (blinking green LED)

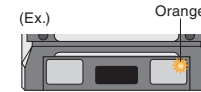

Neutral brake power adjustment is selected (Blinking orange LED)

Each time the SET button is pressed briefly, the flashing LED is switched to indicate the currently selected setting item (see the setting items below for details). Also, pressing the SET button twice shortly will return to the previous item.

Description of each blinking LED pattern

(For details of each item, see the following pages)

[Green flashing twice] Load Program	[Grn+Blu+Red flashing twice] Operation mode
[Blue flashing twice] Drive Frequency	[Blu+Red+Org flashing twice] Cutoff Voltage
[Red flashing twice] Neutral Brake Frequency	[Green flashing 4 times] Full Boost Timing
[Orange flashing twice] Brake Frequency	[Blue flashing 4 times] Boost Start RPM
[Green+Blue flashing twice] Initial Speed	[Red flashing 4 times] Boost Stop RPM
[Green+Red flashing twice] Neutral Brake Power	[Grn+Red flashing 4 times] Full Turbo Timing
[Green+Orange flashing twice] Initial Brake Power	[Blu+Red+Org flashing 4 times] Turbo Start Time
[Blue+Red flashing twice] Full Brake Power	

[Verifying your current settings]

In Select mode, set the LED to the item you want to check the value of, after 2 seconds the LED representing the item & the LED representing the value of the item will blink alternatively. (The LED indicate the item selected > <The LED indicate the value of the selected item)

- ※ Pressing the SET button once returns to the Select mode.
- ※ Refer to P.12 to 20 for the meaning of each displayed values.
- ※ With "Load Program", the value LEDs won't always be displayed.

Setting mode (in ESC setting mode)

Changing to Setting mode

While in Select mode (P.11), move the LED to the setting to be changed using the SET button. Press and hold the SET button 2 seconds or longer. This activates the Settings mode. (While in Settings mode, the motor will not rotate even if the transmitter throttle is operated.)

① Load program (green flashing twice)



In the select mode (green blinking twice), press the SET button for 2 seconds or more to enter the setting mode. Each time the SET button is pressed briefly, the LED pattern changes and the program changes accordingly as shown on the right. Align the LED with your favorite program, and press the SET button for 2 seconds or more. The program is now set and the LED returns to the select mode (green blinking). It is also possible to call the preset program and change each function to the setting of your choice.

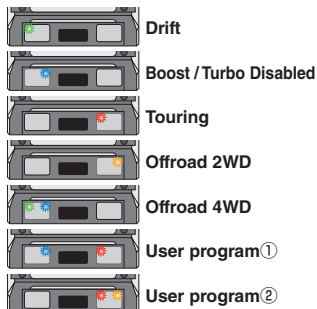

About user program

- This is the area to store each set item on this unit. There are two storage areas (user programs ① and ②) on this unit, but if you need to store more programs, please use TAO II (sold separately).
- Additionally, once all your settings have been adjusted, you can save into a user program.

Caution If the power is turned off without saving to a user program, the settings will be lost.

Important When "boost / turbo disabled" is selected, boost and turbo function (item (11) and later described below) can not be used. In this case, ① to ⑤ are skipped in select mode. Also, the timing angle is fixed at 0°.

② Device frequency (blue flashing twice)



In select mode, the blue LED blink twice, press the SET button for 2 seconds or more to enter the setting mode. Each time the SET button is pressed once, the lighting LED changes and the drive frequency changes as shown on the right.

Adjust the LED to the setting of your choice and press the SET button for 2 seconds or more. The set value is validated and it returns to select mode. The changed value will be reset if the power is turned off without saving. Please save your settings before turning your unit off (P.20).

Commentary The lower the value = strong initial punch/ lowered smoothness. The higher the value = small initial punch/ increased smoothness

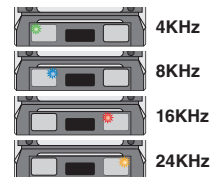

③ Neutral brake frequency (red flashing twice)



In the select mode with the red LED flashing twice, press the SET button for 2 seconds or more to enter the setting mode. Each time the SET button is pressed once, the LED pattern changes and the neutral brake frequency changes as shown on the right. Adjust the LED to the setting of your choice and press the SET button for 2 seconds or more. The set value is validated and it returns to select mode. The changed value will be reset if the power is turned off without saving. Please save your settings before turning your unit off (P.20).

Commentary The lower the value = quicker braking
The higher the value = smoother braking

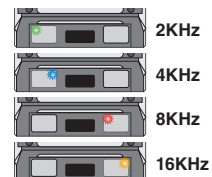

④ Brake frequency (orange flashing twice)



In the select mode with the orange LED flashing twice, press the SET button for 2 seconds or more to enter the setting mode. Each time the SET button is pressed once, the LED pattern changes and the brake frequency changes as shown on the right. Adjust the LED to the setting of your choice and press the SET button for 2 seconds or more. The set value is validated and it returns to select mode. The changed value will be reset if the power is turned off without saving. Please save your settings before turning your unit off (P.20).

Commentary The lower the value = quicker braking
The higher the value = smoother braking

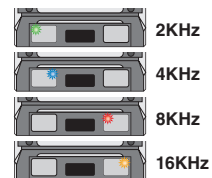

⑤ Initial speed (green+blue flashing twice)



In the select mode with the **green+blue** LED flashing twice, press the SET button for 2 seconds or more to enter the setting mode. Each time the SET button is pressed once, the LED pattern changes and the initial speed value changes as shown on the right. Adjust the LED to the setting of your choice and press the SET button for 2 seconds or more. The set value is validated and it returns to select mode. The changed value will be reset if the power is turned off without saving. Please save your settings before turning your unit off (P.20).

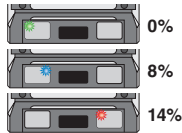

Commentary It is the amount of speed as soon as you begin to pull your throttle lever. The higher the value = higher speed at the beginning of your throttle. Excessive initial speed can cause tire spin or chip gears. Choose your setting carefully.

⑥ Neutral brake power (green+red flashing twice)



In the select mode with the **green+red** LED flashing twice, press the SET button for 2 seconds or more to enter the setting mode. Each time the SET button is pressed once, the LED pattern changes and the neutral brake power value changes as shown on the right. Adjust the LED to the setting of your choice and press the SET button for 2 seconds or more. The set value is validated and it returns to select mode. The changed value will be reset if the power is turned off without saving. Please save your settings before turning your unit off (P.20).

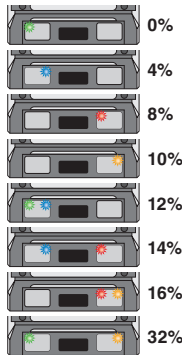

Commentary It is the amount of braking force applied when the throttle is returned to neutral. The higher the value = increased braking force

⑦ Initial brake power (green+orange flashing twice)



In the select mode with the **green+orange** LED flashing twice, press the SET button for 2 seconds or more to enter the setting mode. Each time the SET button is pressed once, the LED pattern changes and the initial brake power value

changes as shown on the right. Adjust the LED to the setting of your choice and press the SET button for 2 seconds or more. The set value is validated and it returns to select mode. The changed value will be reset if the power is turned off without saving. Please save your settings before turning your unit off (P.20).

Commentary It is the brake power that is applied once the throttle is placed in the brake position. The higher the value = stronger initial braking force

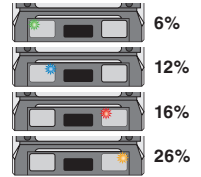

⑧ Full brake power (blue+red flashing twice)



In the select mode with the **blue+red** LED flashing twice, press the SET button for 2 seconds or more to enter the setting mode. Each time the SET button is pressed once, the LED pattern changes and the full brake power value changes as shown on the right. Adjust the LED to the setting of your choice and press the SET button for 2 seconds or more. The set value is validated and it returns to select mode. The changed value will be reset if the power is turned off without saving. Please save your settings before turning your unit off (P.20).

Commentary It is the brake power that is applied when the throttle is in fully braked position. The higher the value = stronger braking force at full braking

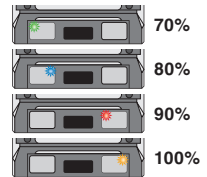

Advice

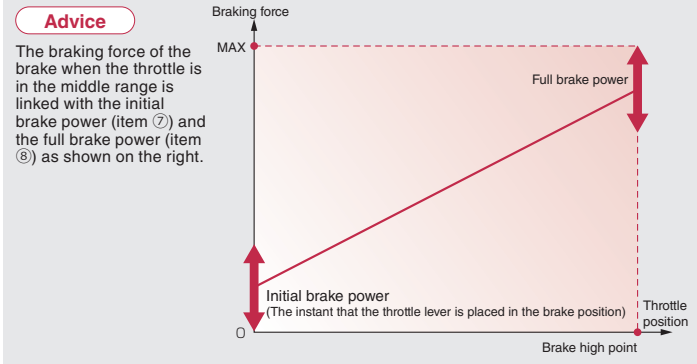

9 Operation mode (grn+blu+red flashing twice)



In the select mode with the **green+blue+red** LED flashing twice, press the SET button for 2 seconds or more to enter the setting mode. Each time the SET button is pressed once, the LED pattern changes and the operating mode changes as shown on the right. Adjust the LED to the setting of your choice and press the SET button for 2 seconds or more. The set value is validated and it returns to select mode. The changed value will be reset if the power is turned off without saving. Please save your settings before turning your unit off (P.20).

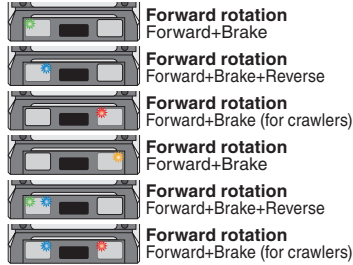

Commentary Switched between normal and reverse motor rotation. Regardless of whether the initial settings have been completed properly, the car may go into reverse once the throttle is applied. If this condition occurs, please use Reverse rotation operation mode. The orange LED will be lit in standby mode when Reverse rotation is selected.

Warning With crawler-oriented settings, the brake will not work and the ESC will switch between forward and reverse instantly. This function must not be used on non-crawler vehicles otherwise damage to the ESC, motor, or gears may occur.

10 Cutoff voltage (blu+red+org flashing twice)



In the select mode with the **blue+red+orange** LED flashing twice, press the SET button for 2 seconds or more to enter the setting mode. Each time the SET button is pressed once, the LED pattern changes and the cutoff voltage value changes as shown on the right. Adjust the LED to the setting of your choice and press the SET button for 2 seconds or more. The set value is validated and it returns to select mode. The changed value will be reset if the power is turned off without saving. Please save your settings before turning your unit off (P.20).

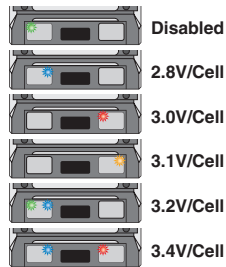

Reference Because the number of cell is automatically recognized, select the voltage per cell. If set to disabled, pay close attention to your runtime.

Commentary It is a function to notify the driver of low voltage condition before the unit reaches critical voltage and performance decrease. When the voltage reaches the cutoff voltage while driving, the green LED will flash and the vehicle will travel very slowly. When disabled is selected, this function will not work. Please be careful about your runtime and other conditions.

About Boost / Turbo Function

What is the boost function? It is a function that increase the electronic timing in conjunction with the motor rpm to **further increase motor rpm**.

What is the turbo function? It is a function that increase the electronic timing when in full throttle to **increase motor rpm**.

Advice

If "boost/turbo disabled" has been selected in Load program, the "boost function" and "turbo function" cannot be used.

When using the "boost/turbo disabled" program, zero timing will be activated, and while in standby, the blue LED will blink in "ESC mode" and the red LED will blink in "Link mode". This is also known as a "Blinky mode". It allows the user understand at a quick glance that the ESC is in zero timing mode and that "boost/turbo" is disabled.

Warning When using "boost+turbo" or "boost" only, please use a motor of 8.5T turn or higher. Damage caused by using a motor with a lower turn count **will not be covered by warranty**.

Caution In general, "boost+turbo" function will overload the ESC/motor. Pay close attention to the heating of the ESC/motor as well as the gear ratio when using these functions.

11 Full boost timing (green flashing 4 times)



In the select mode with the **green** LED flashing 4 times, press the SET button for 2 seconds or more to enter the setting mode. Each time the SET button is pressed once, the LED pattern changes and the boost timing value changes as shown on the right. Adjust the LED to the setting of your choice and press the SET button for 2 seconds or more. The set value is validated and it returns to select mode. The changed value will be reset if the power is turned off without saving. Please save your settings before turning your unit off (P.20).

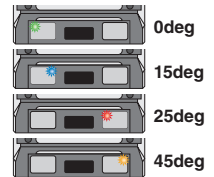

Commentary This determines the maximum value (terminal value) for timing increased through boost.

12 Boost start rpm (blue flashing 4 times)



In the select mode with the **blue** LED flashing 4 times, press the SET button for 2 seconds or more to enter the setting mode. Each time the SET button is pressed once, the LED pattern changes and the boost start rpm value changes as shown on the right. Adjust the LED to the setting of your choice and press the SET button for 2 seconds or more. The set value is validated and it returns to select mode. The changed value will be reset if the power is turned off without saving. Please save your settings before turning your unit off (P.20).

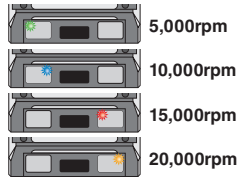

Commentary This determines the motor rpm at which the boost will begin to operate. As this rpm value is set lower, boost will operate from a lower speed/rpm point.

Caution When set low, it is necessary to lighten the drive load and adjust your gear ratio.

13 Boost end rpm (red flashing 4 times)



In the select mode with the **red** LED flashing 4 times, press the SET button for 2 seconds or more to enter the setting mode. Each time the SET button is pressed once, the LED pattern changes and the boost end rpm value changes as shown on the right. Adjust the LED to the setting of your choice and press the SET button for 2 seconds or more. The set value is validated and it returns to select mode. The changed value will be reset if the power is turned off without saving. Please save your settings before turning your unit off (P.20).

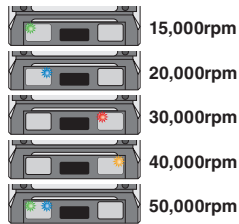

Commentary This determines the motor rpm at which the boost will end. As this rpm value is set higher, boost will operate to a higher speed/rpm point.

Caution Please make sure to set the boost end rpm higher than the value of your boost start rpm. The sudden jump in timing may overload the ESC, therefore it is advised to start with a much higher boost end rpm and progressively lower timing as you get comfortable with your gearing.

14 Full turbo timing (green+red flashing 4 times)



In the select mode with the **green+red** LED flashing 4 times, press the SET button for 2 seconds or more to enter the setting mode. Each time the SET button is pressed once, the LED pattern changes and the full turbo timing value changes as shown on the right. Adjust the LED to the setting of your choice and press the SET button for 2 seconds or more. The set value is validated and it returns to select mode. The changed value will be reset if the power is turned off without saving. Please save your settings before turning your unit off (P.20).

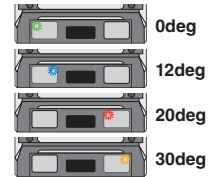

Commentary This determines the amount of turbo timing added at full throttle.

Important When using both boost and turbo function at the same time, make sure the total value of full boost timing and full turbo timing are less than 60°

15 Rev-Limiter rpm (blue+red+org flashing 4 times)



In the select mode with the **blue+red+orange** LED flashing 4 times, press the SET button for 2 seconds or more to enter the setting mode. Each time the SET button is pressed once, the LED pattern changes and the rev-limiter rpm value changes as shown on the right. Adjust the LED to the setting of your choice and press the SET button for 2 seconds or more. The set value is validated and it returns to select mode. The changed value will be reset if the power is turned off without saving. Please save your settings before turning your unit off (P.20).

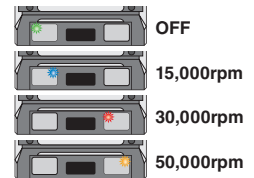

Commentary This function limits the output of the motor so that the rpm does not exceed the set value.

Saving user program (current value)

In SELECT mode, pressing the SET button 4 times quickly causes all LEDs to flash, and then automatically switches to the display that selects the save destination of the user program. The green LED is the user program ①, the orange LED is the user program ②. Each time you press the SET button, the save destination is switched. After selecting the save destination, press the SET button for 2 seconds or more to save it and return to the **standby mode**.



Commentary The saved user programs can be called up by the program load function mentioned earlier.

About the factory preset program

When shipped from the factory, the unit is preset with the [Drift] program (see the table above for the setting values of each item). Please change each set of value according to your preference (For changing method, see P.10 to P.19).

Error signal during driving (LED flashing pattern)

Below is a summary of the LED signal pattern that occurs when something abnormal is detected while driving. Refer to P.8 to P.9 “Checking standby status” for the LED lighting / flashing pattern in standby mode.

Motor stops with all LEDs blinking ~ Sensor error

When the sensor signal is interrupted or becomes unstable for some reason, the motor stops with all the LEDs blinking. When all the LEDs are blinking, no button operation is accepted, so remove the battery and turn off the power.



[Possible cause of signal generation]

- An error has occurred in the motor sensor.
- Sensor cable has poor contact
- The sensor cable is affected by radiation noise from the motor cable and the sensor signal is disturbed.

[Workaround]

- Replacing the motor sensor
- Replacing the sensor cable
- Install the sensor cable and motor cable as far apart as possible

※Disturbance of the sensor signal may cause abnormal heat generation and damage to the ESC and motor. Do not bundle the sensor cable with the motor connection cable. Install them as far apart as possible.

Error signal during driving (LED flashing pattern)

LED green blinks and runs at low speed ~ Low voltage cut-off

When the ESC battery terminal voltage drops to the cut-off voltage set on P.16, the standby LED lights up and flashes, and the green LED will be flashed and drive speed is going to low.

Green LED blinking



Important The condition to detect the cut-off voltage is not "Battery voltage" but "ESC battery terminal voltage". If the contact condition of the connector to which the battery is connected and the welded state of the solder bonding the connector are insufficient, that portion will have a large electrical resistance, and the voltage detected at the ESC terminal will be far below the battery voltage. If there is a large difference between the set cut-off voltage and the actual battery voltage at the time of cut-off operation, the reason may be due to the connector to which the battery is connected or the solder welding location of the connector. In such cases, the ESC or motor performance may not be fully achieved. It is recommended to replace the connector or rework the solder.

LED orange blinks and runs at low speed ~ Heat protection

When the ESC overheats due to driving and reaches the specified temperature, the orange LED blinks in addition to the standby LED lighting / flashing, and the vehicle runs at low speed.

Orange LED blinking



In this case, stop driving until the ESC temperature drops.

If the heat protection is activated in a short driving time, the gear ratio setting may be overloaded. In this case, check each setting status.

Protection circuit for Battery reverse connection

This product is equipped with a reverse battery protection circuit, so the ESC circuit is protected if the reverse connection less than about 10 seconds. (Some heat is generated when the protection circuit is activated.) When the battery is connected in reverse, the LED on the back of the battery terminal will turn red. Remove the battery immediately and reconnect it correctly.





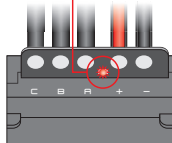







※**The protection circuit is automatically activated when the battery is reversely connected.**

Alert red LED light



Important This function protects only the ESC circuit board when the battery is reversely connected. Capacitors connected to ESC such as Chevalier series are not protected, so be careful when connecting batteries.

Standby signal LED quick reference table

LED Color	LED on	LED Blinking
Green  	—	Under Cut-off operation If the cutoff function is activated, the RC car runs at low speed (cutoff voltage setting = see page 16 bottom of the instruction manual).
Blue  	Setting Mode = ESC Mode In Program card mode (MC link mode) = LED Off (See P.10 of the instruction manual)	Setting Mode = ESC Mode & Boost : OFF and Turbo : OFF A signal corresponding to the regulation of touring car competition.
Red  	Setting Mode = Link Mode In ESC Mode = LED Off (see P.10 of the instruction manual)	Setting Mode = Link Mode & Boost : OFF and Turbo : OFF A signal corresponding to the regulation of touring car competition.
Orange  	Reverse driving possible At the time of reverse driving cancellation = Off (How to switch reverse driving ON / OFF = See P.16 of the instruction manual)	Heat protection activated If the Heat protection is activated, the RC car runs at low speed.
All Colors    	—	Motor sensor signal transmission error There is a possibility that the motor sensor is out of order or the sensor cable is not energized.



After initial setting is performed

Press and hold the POWER button for 2 to 3 seconds while the power is off

LED (green + orange) blinks for 3 seconds, LED (green) flashes

Initial setting of radio throttle position

In Normal State Press the POWER button

LED (green + red) blinks for 3 times, LED (green + orange) flashes 4 times

Standby state (runnable)

ESC mode (blue LED) (blinking: boost and turbo invalid)
Program card mode (Red LED) (blinking: boost, turbo invalid)

Press and hold the set button for more than 4 seconds to change mode

Storage Location Selection

User program ① (Green LED)
Every time the set button is pressed once, the storage location is switched to ① or ②.

User program ② (orange LED)

It automatically shifts to selection of save destination.

Program saving (All LED blinks)

When Saving

(Note) Since the changed value is reset when the power is turned off, be sure to save the setting value at the end of your programming.

※ If you select "Boost / Turbo Invalid" in "Program Load", the functions below full boost advance can not be used and will be skipped. In this case, the timing angle is fixed at 0°.

Select mode (cannot run)

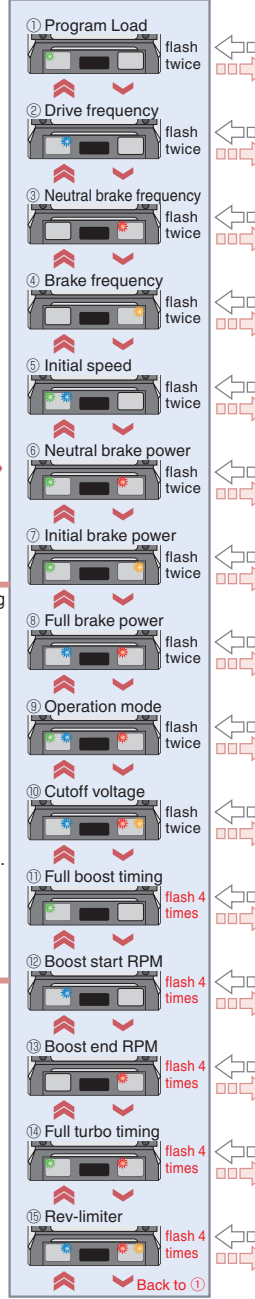

Setting mode (cannot run)

Setting Item	Option 1	Option 2	Option 3	Option 4
Functional overview	Drift Off-Road 2WD User Program 1	Non Boost Off-Road 4WD User Program 2	Touring	
Drive frequency (kHz)	4kHz	8kHz	16kHz	24kHz
Neutral brake frequency (kHz)	2kHz	4kHz	8kHz	16kHz
Brake frequency (kHz)	2kHz	4kHz	8kHz	16kHz
Initial speed (%)	0%	8%	14%	
Neutral brake power (%)	0%, 12%	4%, 14%	8%, 16%	10%, 32%
Initial brake power (%)	6%	12%	16%	26%
Full brake power (%)	70%	80%	90%	100%
Operation mode	(Fwd Rotation)Fwd/Brk (Fwd Rotation)Fwd/Rev (Rev Rotation)Fwd/Brk/Rev	(Fwd Rotation)Fwd/Brk/Rev (Rev Rotation)Fwd/Brk (Rev Rotation)Fwd/Rev		
Cutoff voltage (V / Cell)	NONE 3.1V/Cell	2.8V/Cell 3.2V/Cell	3.0V/Cell 3.4V/Cell	
Full boost timing (deg)	0deg	15deg	25deg	45deg
Boost start RPM	5,000rpm 20,000rpm	10,000rpm	15,000rpm	
Boost end RPM	15,000rpm 40,000rpm	20,000rpm 50,000rpm	30,000rpm	
Full turbo timing (deg)	0deg	12deg	20deg	30deg
Rev-limiter	OFF 50,000rpm	15,000rpm	30,000rpm	

RAD Preset setting value / settable range comparison table

Setting items	Preset initial value				Settable range		Functional overview	
	Drift	Boost/Turbo Invalid	Touring	Off-road 2WD	Off-road 4WD	RAD Unit		TAOIII (Ver.1.26~)
Drive frequency (kHz)	16	16	4	4	16	4~24 (4 Kinds)	1~32 (24 Kinds)	Determine the throttle feeling (quick or mild)
Neutral brake frequency (kHz)	16	16	8	2	8	2~16 (4 Kinds)	0.5~32 (24 Kinds)	Determine the brake feeling (quick or mild) that will be applied when the throttle returns to the neutral position while driving.
Brake frequency (kHz)	8	2	2	2	8	2~16 (4 Kinds)	0.5~32 (24 Kinds)	Determine the brake feeling (quick or mild) that will be applied when the throttle is on the brake side during turning.
Initial speed (%)	8	0	8	14	8	0 · 8 · 14 (8 Kinds)	0~50 (26 Kinds)	Determines the initial speed when starting acceleration from a stopped state. The bigger the number, the sharper the start.
Neutral brake power (%)	16	4	16	16	24	0~32 (8 Kinds)	0~100 (51 Kinds)	Determines the brake power applied when returning the throttle to the neutral position while driving.
Initial brake power (%)	26	6	26	26	12	6~26 (4 Kinds)	0~100 (51 Kinds)	Determines the brake power to be applied at the moment when the throttle is put on the brake side while driving.
Full brake power (%)	100	100	100			70~100 (4 Kinds)	0~100 (51 Kinds)	Determines the brake power applied when the throttle is put in full brake while driving.
Max forward speed (%)						100	50~100 (26 Kinds)	It is a function to limit the maximum speed on the forward side of the throttle.
Max reverse speed (%)						25	25~100 (4 Kinds)	It is a function to limit the maximum speed on the reverse side of the throttle.
Operation mode						N / F / B / R (forward rotation, reverse enabled)	6 Kinds	Determine the direction of motor rotation, presence of brake, and presence of reverse function.
Cutoff voltage (V / Cell)			3.2			OFF & 2.8~3.4	OFF & 2.6~3.6	When the battery voltage drops to the set value, the ESC will inform the driver that the battery voltage is decreasing by running at ultra low speed.
Full boost timing (deg.)	0	-	25	0	0	0~45 (4 Kinds)	0~60 (61 Kinds)	It is the maximum timing angle value achieved by the boost function.
Boost start rotation speed (rpm)	5000	-	10000	5000	5000	5000~20000(4 Kinds)	1000~4000(79 Kinds)	This is the motor speed at which boost starts.
Boost end rotation speed (rpm)	20000	-	30000	20000	20000	15000~50000(5 Kinds)	10000~10000(181 Kinds)	This is the motor speed at which boost ends.
Throttle Boost Control			OFF			-	ON / OFF	It is a safety feature that automatically regulate the rotation speed to prevent sudden change in motor rotation speed under sudden throttle action.
Turbo activation						At Full Throttle	3 Types	Determines the factor that trigger the turbo activation. (When full throttle or when set rpm value is reached or both)
Full turbo timing (deg.)	12	-	20	12	0	0~30 (4 Kinds)	0~30 (31 Kinds)	It is the maximum timing angle value achieved by the turbo function.
Turbo start rotation speed (rpm)	20000	-		20000			10000~50000(81 Kinds)	This is the motor speed at which the turbo starts operating.
Turbo on slope (deg./0.1 sec.)	3	-	9	3	3	-	1~25	It is the ramping speed at which turbo reaches full timing from the moment it activates. Larger value equal to a faster timing increase.
Turbo off slope (deg./0.1 sec.)	6	-		6		-	1~25	It is the ramping speed at which the turbo decrease from full timing to inactive. Larger value equal to faster timing decrease.
Turbo start delay time (sec.)	0.15	-		0.15		-	0~1.00 (21 Kinds)	It is the time it takes for the turbo to turn ON once full throttle is reached.
Turbo off delay time (sec.)	0	-		0		-	0~1.00 (21 Kinds)	It is the time it takes for the turbo to turn OFF once full throttle is released.
Rev-limiter (rpm)			OFF			OFF · 15000 · 30000 · 50000	OFF & 10000~10000(2 Kinds)	The output to the motor is capped at an arbitrary rpm value. Unexpected speed increase can be prevented, such as when using a high-speed motor.
Free zone adjustment (%)			6			-	1~10 (10 Kinds)	Adjust the output characteristics at the moment the throttle shifts from neutral to drive. Lower value create a quicker output, higher value create a mild/smooth output.
Torque Level**			0			-	-5~+5 (11 Kinds)	Setting value 0 is liner condition. Increasing the value results in acceleration with torque and slow deceleration. Also, decreasing the value results in slow acceleration and rapid deceleration.
Torque end point(%)**			100			-	20~100 (17 Kinds)	Set the throttle range where the torque level function operates. (Operates from 0% to the set value) Outside the "torque end point" range outputs normal characteristics.

※※※ [Important] "Torque level" and "Torque end point" function can operate only when using our brushless motor "LUXON AGILE" and "FLEDGE". When using a motor of our company "LUXON BS" and "LUXON", or a motor of other manufacturers, setting isn't possible or it doesn't operate properly.